

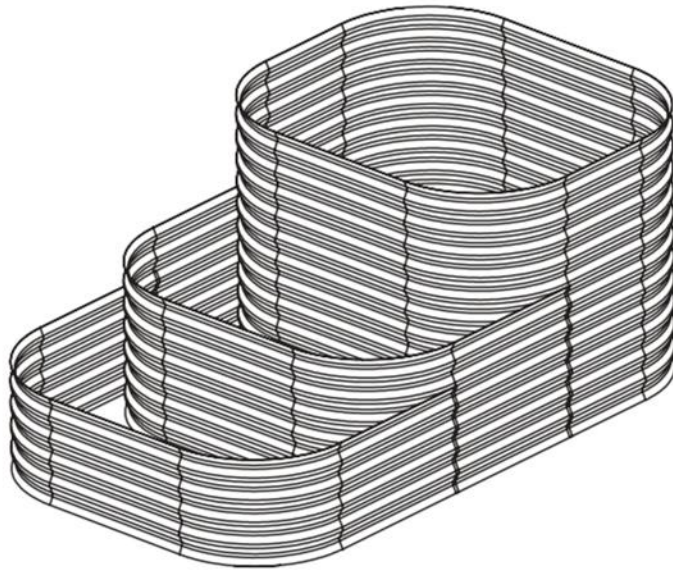







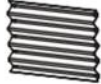

SADAN TYP 6

154x106x78



1	4x	
2	2x	
3	2x	
4	2x	
5	3x	
6	2x	
7	3x	
8	144x	
9	144x	
10	1x	
11	3x	

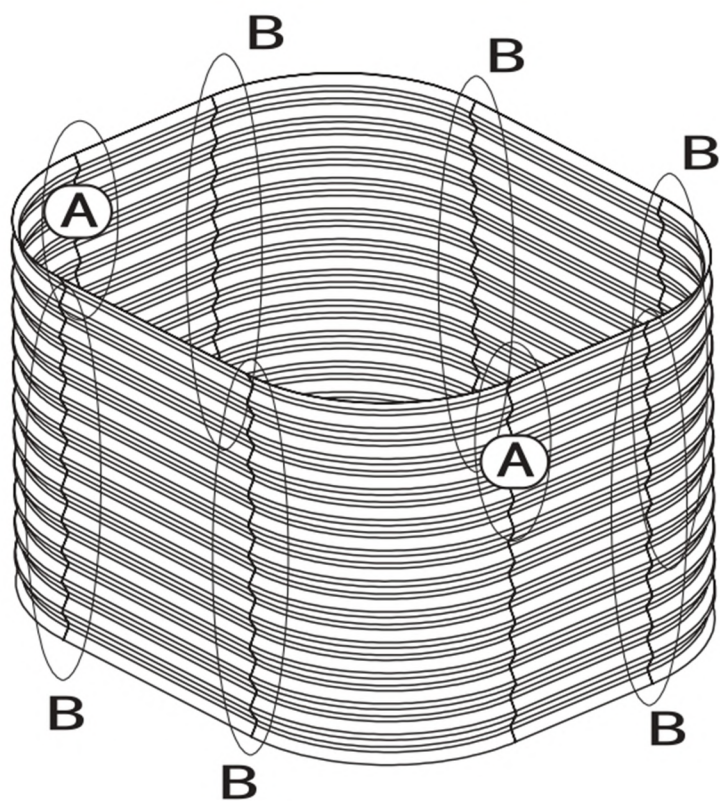
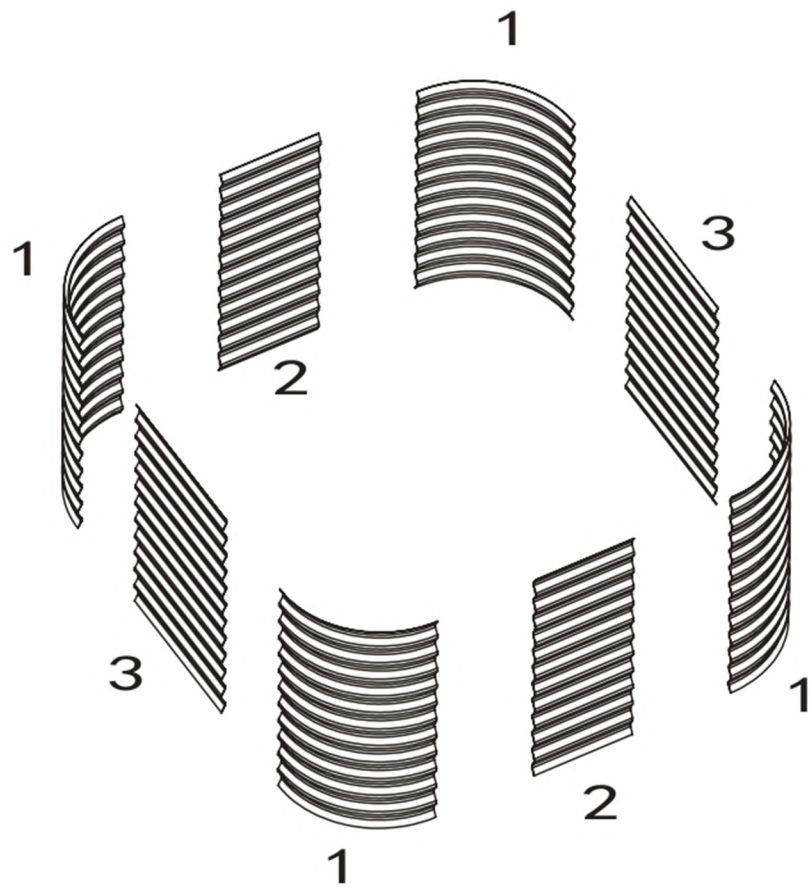

SK: Časť A zaistíte len 5 skrutkami.
 CZ: Zajistěte pouze 5 šroubů na části A.
 HU: Csak 5 csavart rögzítsen az A részre.
 HR: Samo stegnite 5 vijaka na dijelu A.
 RO: Prindeți doar 5 șuruburi pe piesa A.
 SI: Na delu A pritrdite samo 5 vijakov.

